

# Stempel | 1 Anfrage Bestellung

Absender:

---



---



---



---

**Max Hering Werbetechnik** GmbH & Co. KG

Schütte-Lanz-Str. 7a  
26135 Oldenburg

**Tel.** 0441 20 68 2-0

**Fax** 0441 20 68 2-22

info@max-hering.de

max-hering.de

max-hering.werbeland-partner.com

barrierefreie-schilder.de

Telefon (bitte immer angeben): \_\_\_\_\_

Gewünschter Liefertermin: \_\_\_\_\_

**Bei Ihrer Bestellung bitten wir folgende Angaben zu beachten:**

- Ohne Angaben zu Schrift- oder Satzmuster wird grundsätzlich Helvetica als Standardschrift verwendet.
- Sollten zusätzlich keine Schriftgrößen angegeben sein, wird der Stempel optisch bis 6x3 cm gefertigt.

**Text:**

1. Zeile \_\_\_\_\_

2. Zeile \_\_\_\_\_

3. Zeile \_\_\_\_\_

4. Zeile \_\_\_\_\_

5. Zeile \_\_\_\_\_

6. Zeile \_\_\_\_\_

7. Zeile \_\_\_\_\_

8. Zeile \_\_\_\_\_

**Stempelart:**

**Anz.      Format | Kissenfarbe**

Holzstempel \_\_\_\_\_

Selbstfärber \_\_\_\_\_

Printy \_\_\_\_\_

**Satzanordnung:**

<input type="checkbox"/> linksbündig	<input type="checkbox"/> zentriert	<input type="checkbox"/> rechtsbündig	<input type="checkbox"/> Blocksatz
Eveline Hansen Krankenschwester Jagdweg 14 26543 Oldenburg	Eveline Hansen Krankenschwester Jagdweg 14 26543 Oldenburg	Eveline Hansen Krankenschwester Jagdweg 14 26543 Oldenburg	Eveline Hansen Krankenschwester Jagdweg 14 26543 Oldenburg

## Stempel | 2

Schriftmuster: \_\_\_\_\_

- |                                |                                     |                                |
|--------------------------------|-------------------------------------|--------------------------------|
| 1  <i>Apple Chancery</i>       | 12  <i>Englische Schreibschrift</i> | 23  <b>Revue D</b>             |
| 2  <i>Aristus D</i>            | 13  Futura T Medium                 | 24  <b>Roctus T</b>            |
| 3  Avant Garde Book            | 14  Handel Gothic                   | 25  Taffy                      |
| 4  <b>BANK GOTHIC</b>          | 15  Helvetica Condensed             | 26  <b>Times Script</b>        |
| 5  Bauhaus Medium              | 16  Helvetica light                 | 27  Times New Roman            |
| 6  Benguiat Book               | 17  Helvetica roman                 | 28  <i>Times Italic</i>        |
| 7  <i>Brush Script</i>         | 18  <b>Helvetica Bold</b>           | 29  <b>Triplex Bold</b>        |
| 8  <i>caflisch Script Bold</i> | 19  <b>Hobo Std</b>                 | 30  <i>Triplex Bold Italic</i> |
| 9  Comic Sans MS               | 20  META-CAPS                       | 31  <b>VAG Rounded Bold</b>    |
| 10  COPPERPLATE                | 21  <i>Murray Hill D</i>            | 32  <i>Van Dijk D</i>          |
| 11  <b>Crille T</b>            | 22  PEIGNOT DEMI                    | 33  <i>Zapf Chancery</i>       |

Andere Schrift: \_\_\_\_\_

Lagerstempel: \_\_\_\_\_

- |  |                                |
|--|--------------------------------|
| 1  <b>Abschrift</b>                            | 14  <b>G e p r ü f t</b>       |
| 2  Betrag dankend erhalten                     | 15  <b>Gutschrift</b>          |
| 3  Betrag dankend erhalten<br>....., den ..... | 16  <b>Infobrief</b>           |
| 4  <b>Bezahlt</b>                              | 17  <b>Infopost</b>            |
| 5  <b>Büchersendung</b>                        | 18  <b>K o p i e</b>           |
| 6  <b>Duplikat</b>                             | 19  <b>Lieferschein</b>        |
| 7  <b>Eilt</b>                                 | 20  <b>Maxibrief</b>           |
| 8  <b>Eilt sehr</b>                            | 21  <b>Muster</b>              |
| 9  <b>Einschreiben</b>                         | 22  <b>Nur zur Verrechnung</b> |
| 10  <b>Entwertet</b>                           | 23  <b>Original</b>            |
| 11  <b>Entwurf</b>                             | 24  <b>Päckchen</b>            |
| 12  <b>Erledigt</b>                            | 25  <b>Postgut</b>             |
| 13  <b>Gebucht</b>                             | 26  <b>Rechnung</b>            |

## Stempel | 3

Stempelmuster: \_\_\_\_\_

- 1| **DR. HORST JANSSEN**  
FRAUENFACHARZT  
OSTERKAMPSWEG 248  
80357 MÜNCHEN
- 2| **Brigitte Kemmerle**  
Gutenbergstraße 7  
60534 Obertshausen  
Tel.: 061 04 / 4329
- 3| **Franz Hermeling**  
Kleine Straße 5 - 6  
44788 Münster (Westf.)  
Telefon 0251 / 32033
- 4| *Dr. Hasso von Zitzewitz*  
Rechtsanwalt und Notar  
Schloßweg 20 - Tel. 089 / 30 38 44  
82468 München  
Postbankkonto München 3344 62 - 807
- 5| Tabak - Großhandlung  
**Kurt Schumacher KG**  
Bremer Straße 30  
32435 Hannover  
Tel. 0511 / 13426
- 6| **Teusner & Lammers**  
Autoklempnerei und Kühlerbau  
Heidschnuckenweg 1  
66845 Landsweiler-Reden
- 7| *Lulu's Boutique*  
Lulu Rodier  
Dornstraße 130  
28798 Hude
- 8| *Kai Heinersdorfer*  
Töpferei  
Bremer Straße 235  
26926 Oldenburg
- 9| **Georg Schwarting**  
Reifen-Vertretung  
Dürerstraße 19  
26275 Emden
- 10| Corinna Lübbling  
Kunsthandlung  
Barbarossastraße 206  
28765 Bremen
- 11| **Annette's Salon**  
Damensalon  
Oldenburger Straße 220  
44622 Nordhorn
- 12| **Auto Bigalke**  
Autohaus  
Huntemannstraße 200  
26954 Nordenhamm  
E-Mail: auto.bigalke@t-online.de
- 13| *Karl - Heinz Wintermann*  
Installateurmeister  
Tweelbäker Tredde 47 - Tel.: 04 41 / 43 89  
63502 Bad Nauheim
- 14| **Betonwerk Lux**  
Industriestraße 1-2  
62483 Wiesbaden  
Telefon 061 21 / 23 80 28  
Telefax 061 21 / 23 80 28
- 15| *Horst Altmeyer*  
Urwaldstraße 15  
Telefon 04452 / 220  
29343 Neuenburg
- 16| *Café Wachtendorf*  
Inh. Brigitte Niemann  
Hindenburgstr. 12  
60814 Crumstadt
- 17| **HEINRICH BANNMÜLLER**  
Mediengestalter  
BREMER STRASSE 20  
28790 SCHWANEWEDDE
- 18| **Bäckerei Kock**  
Hornstr. 12  
85432 Nürnberg  
Tel. 09 101 / 21 31 27
- 19| *Eveline Hansen*  
Krankenschwester  
Jagdweg 14  
26543 Oldenburg
- 20| *Dietmar Biermann*  
Handelsvertreter  
Dachsweg 6, Tel. 04 41 73 45 89  
49002 Heidelberg
- 21| **Berngard Böse**  
Zeugstraße 8  
26725 Obenstrohe
- 22| Katja Gloystein  
Große Straße 60  
30906 Verden / Aller
- 23| **Irma Wintermann**  
Feldweg 20  
29623 Aurich
- 24| *Dr. Lila Joran*  
Peterstraße 26  
63036 Gießen
- 25| **Dr. Paul Kuck**  
Salbeistr. 7  
65277 Worms
- 26| **Irma Kehse**  
Taubenstr. 24  
85012 Neuhof
- 27| *Christine Laube*  
Sandberg 50  
83924 Passau
- 28| **Rommy Schneider**  
Achterdiek  
26078 Oldenburg
- 29| **HORST CORDES**  
KENNEDYSTR. 5  
22767 HAMNURG
- 30| Lilly Havekost  
Gartenstraße 10  
70384 Stuttgart

# Stempel | 4

## PROFESSIONAL LINE

Datumstempel: \_\_\_\_\_

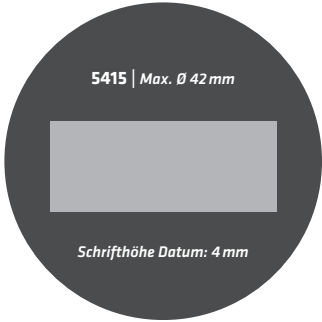
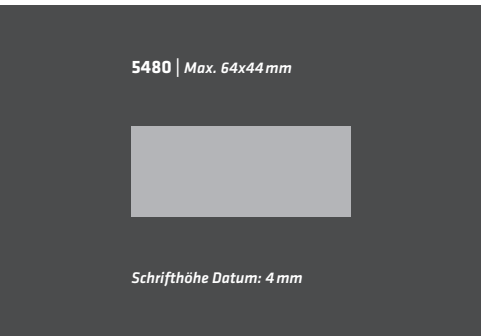
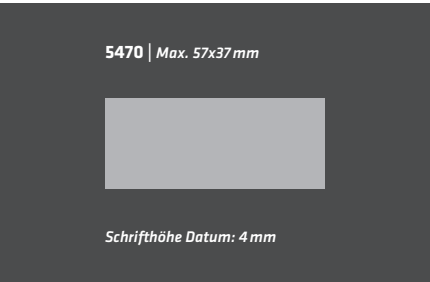
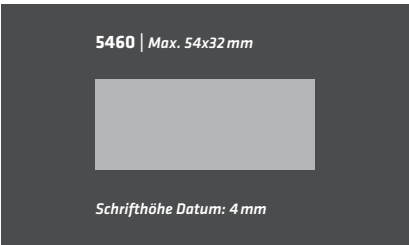
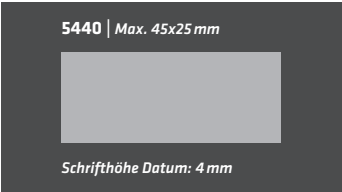
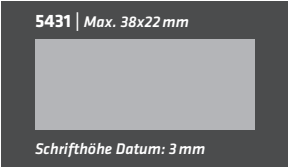
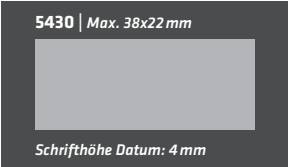

Textstempel: \_\_\_\_\_

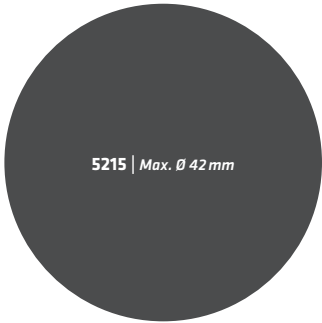
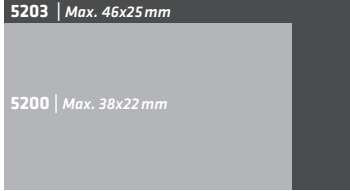

# Stempel | 5

## PRINTY LINE

Textstempel: \_\_\_\_\_



4921 | Max. 11x11 mm



4922 | Max. 18x18 mm

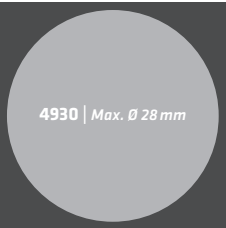

4923 | Max. Ø 28 mm

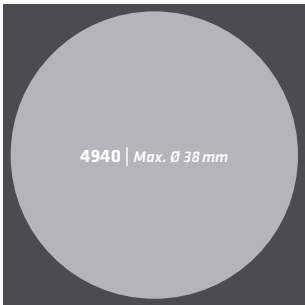

4924 | Max. Ø 38 mm

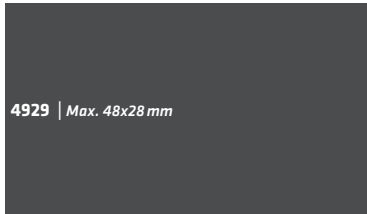
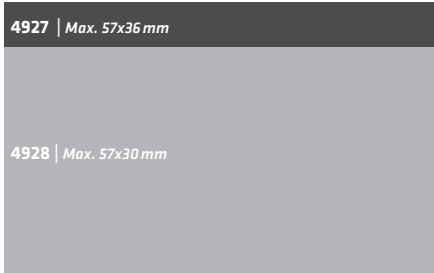
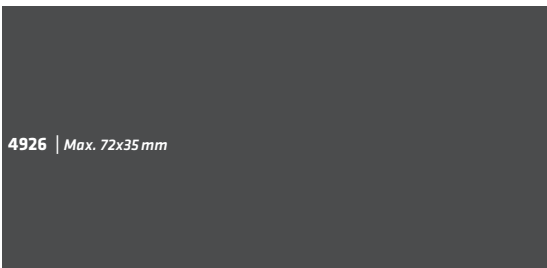

Datumstempel: \_\_\_\_\_

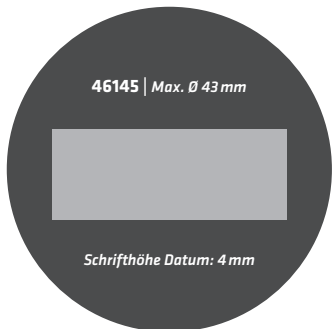
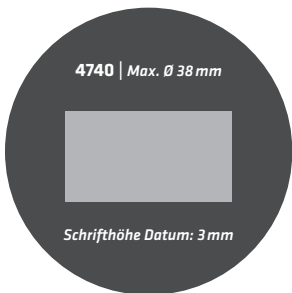
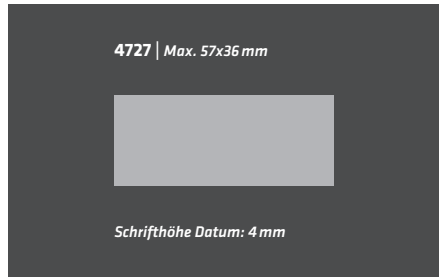
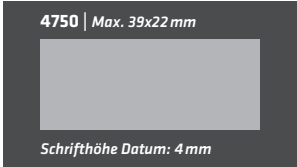
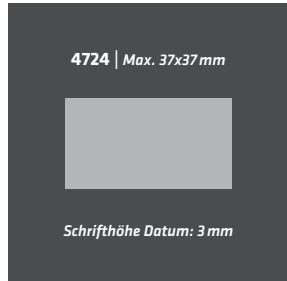

# Stempel | 6

Rund - und Ovalstempel: \_\_\_\_\_

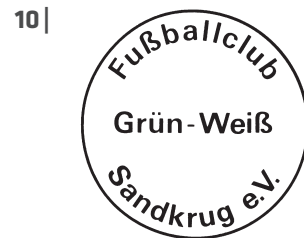
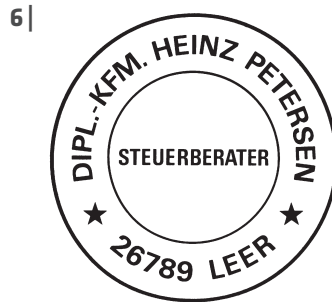
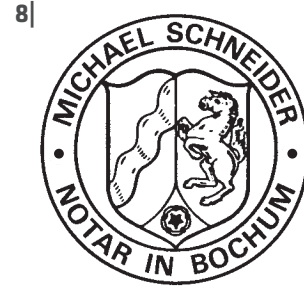

Anmerkungen  
Sonstiges:

---

---

---

---

---

---

---

---

---

---